

FRONT VIEW 1:55

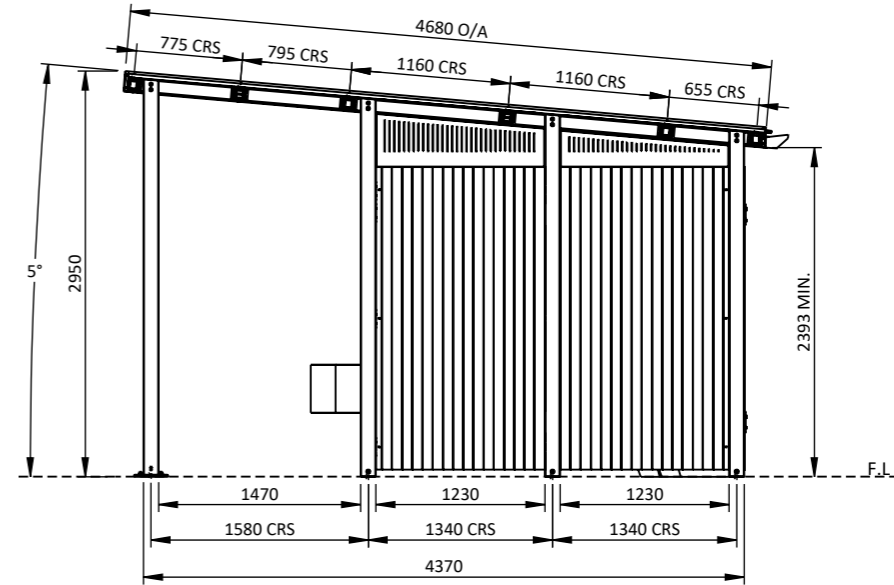

SIDE VIEW 1:55

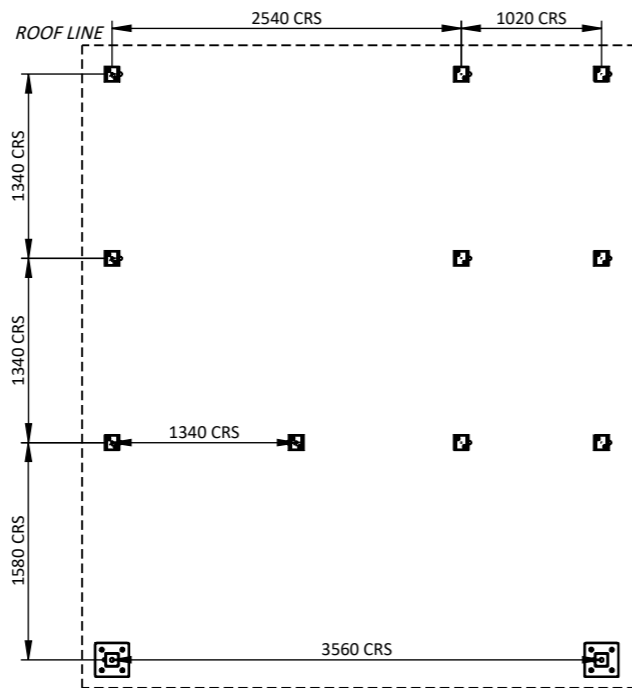

FOUNDATION PLAN 1:55

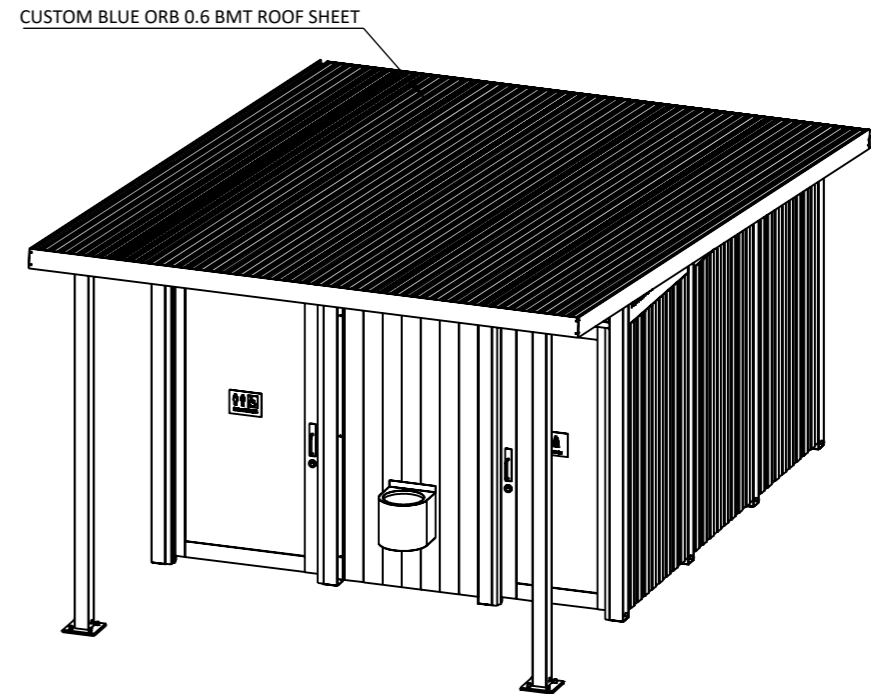

DIMETRIC VIEW 1:55

GOSSI
PARK & STREET FURNITURE

1082 Kingsford Smith Drive
EAGLE FARM - QLD 4009
Phone: (07) 3877 2856
Fax: (07) 3877 2890
www.gossi.com.au Email:
sales@gossi.com.au

©Copyright - This drawing is the property of G. James Glass & Aluminium Pty Ltd it must not be copied or shown to third parties without written consent

PROJECT	AMT-101		
TITLE	GENERAL ARRANGEMENT		
DATE	20/09/2024	SCALE	1:55
DRAWING NUMBER	AMT-101-SLS-ISSUE-B-1		

GENERAL MATERIALS:

- Posts, framing and roofing components in extruded aluminium.
- Roof sheeting in corrugated profile coated steel.

FINISHES

- Posts, framing and brackets in Class AA25 Anodising finishes, Polyester Powder Coating or wood look aluminium.
Note: Colour may vary between alloys.
- Spigots in Polyester Powder Coating finishes.
Note: 60 Micron minimum on visible faces.

HARDWARE

- Stainless steel anti-vandal fixings.
- Roof screws colour matched roof sheets.

BUILDING COMPLIES WITH AS 1428.1 - 2021 DISABILITY ACCESS STANDARDS

UNISEX PWD WATER CLOSET COMPLIES WITH AS 1428.1 - 2021 STANDARDS

UNISEX AMB WATER CLOSET COMPLIES WITH AS 1428.1 - 2021 STANDARDS

LEGEND:

- WD = Disability compliant toilet pan
- WA = Ambulant compliant toilet pan
- WAC = Ambulant compliant toilet pan (with cistern)
- WDC = Disability compliant toilet pan (with cistern)
- RC = In-wall remote cistern
- BD = Disability compliant handwashing basin
- B = External Basin
- LDR = LH disability compliant hand rail
- RDR = RH disability compliant hand rail
- AR = Ambulant compliant hand rail
- CT = Changing table
- SH = Shelf
- ALH = Anti Legature coat Hanger
- EB = Electrical Box
- FPSS = Front Privacy Screen Spigot

UNISEX PWD = Unisex disability compliant water closet

UNISEX AMB = Unisex ambulant compliant water closet

EXCLUSION ZONES = - - - - -

CIRCULATION SPACES = - - - - -

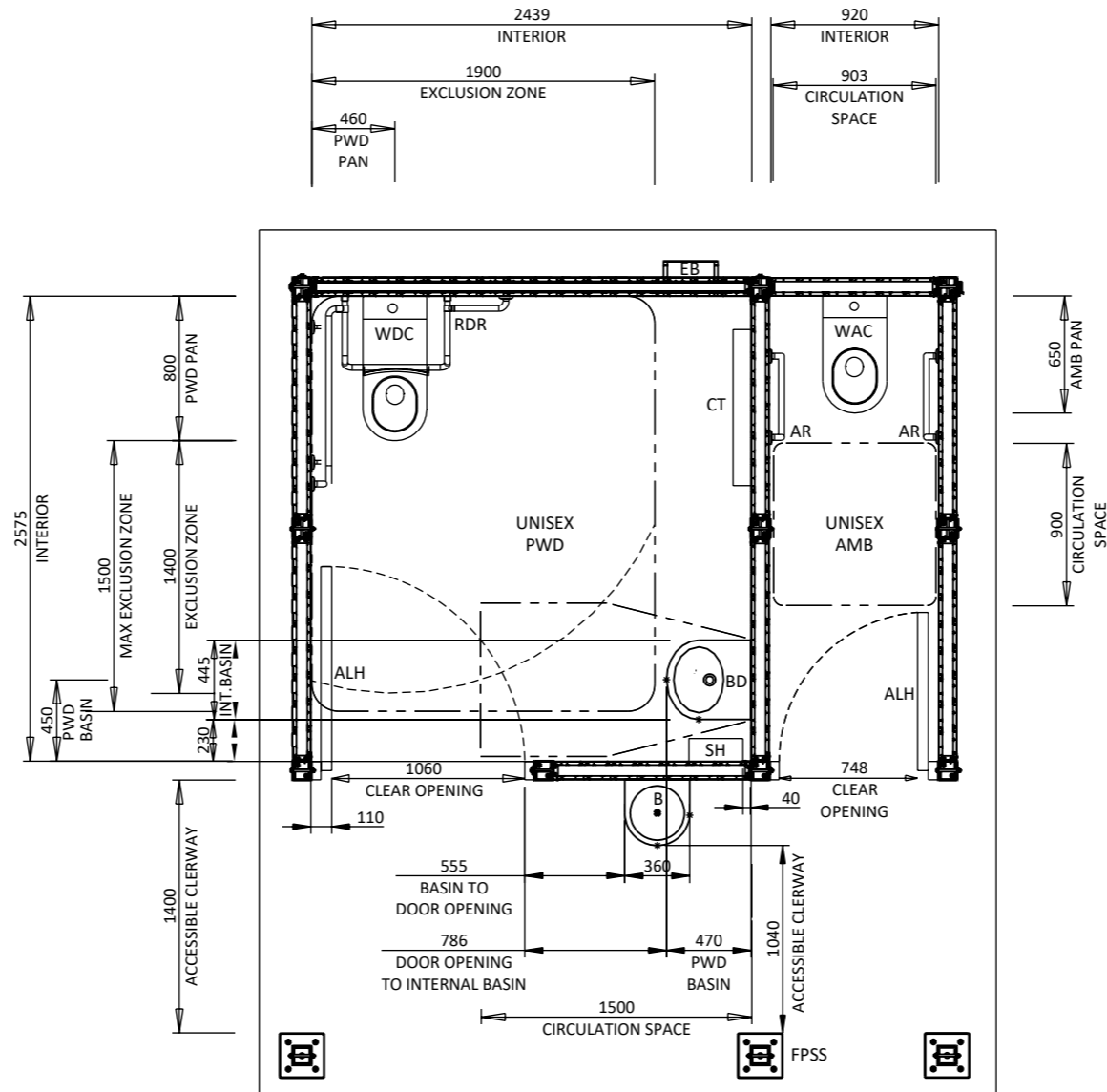

FLOOR PLAN
1:40



1082 Kingsford Smith Drive
EAGLE FARM - QLD 4009
Phone: (07) 3877 2856
Fax: (07) 3877 2890
www.gossi.com.au Email:
sales@gossi.com.au

©Copyright - This drawing is the property of G. James Glass & Aluminium Pty Ltd it must not be copied or shown to third parties without written consent

PROJECT	AMT-101		
TITLE	FLOOR PLAN		
DATE	20/09/2024	SCALE	1:40
DRAWING NUMBER	AMT-101-SLS-ISSUE-B-2		
			A3

GENERAL MATERIALS:

- Posts, framing and roofing components in extruded aluminium.
- Roof sheeting in corrugated profile coated steel.

FINISHES

- Posts, framing and brackets in Class AA25 Anodising finishes, Polyester Powder Coating or wood look aluminium.
Note: Colour may vary between alloys.
- Spigots in Polyester Powder Coating finishes.
Note: 60 Micron minimum on visible faces.

HARDWARE

- Stainless steel anti-vandal fixings.
- Roof screws colour matched roof sheets.

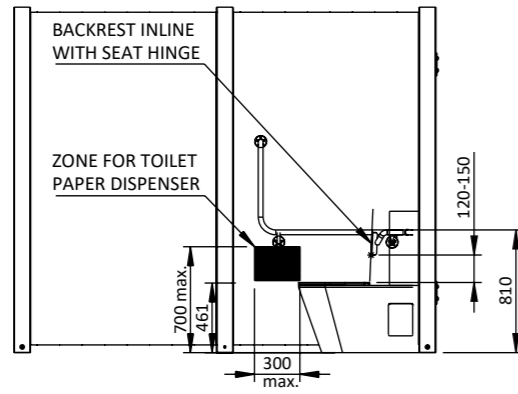

○ PWD LHS WALL

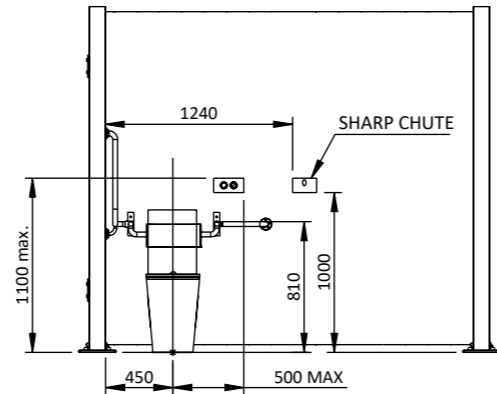

○ PWD REAR WALL

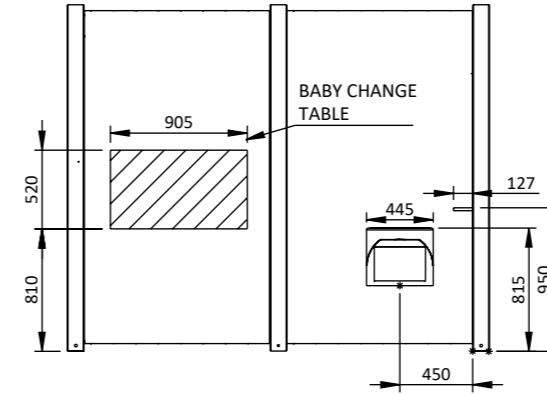

○ PWD RHS WALL

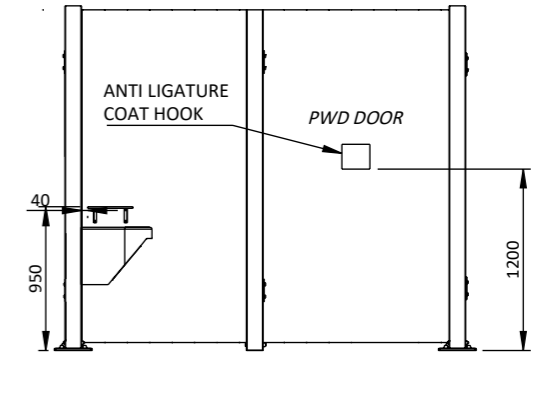

○ PWD INTERNAL FRONT WALL

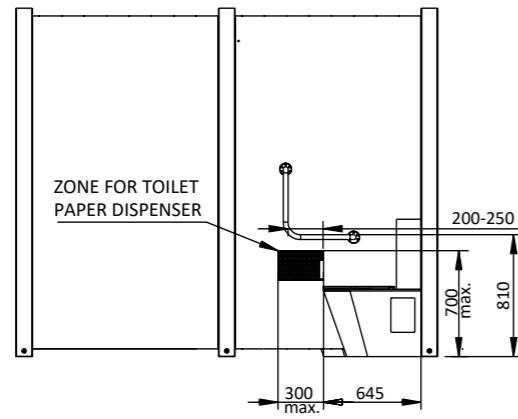

○ AMB LHS WALL

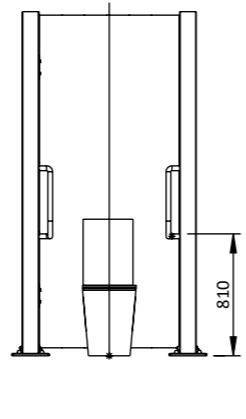

○ AMB REAR WALL

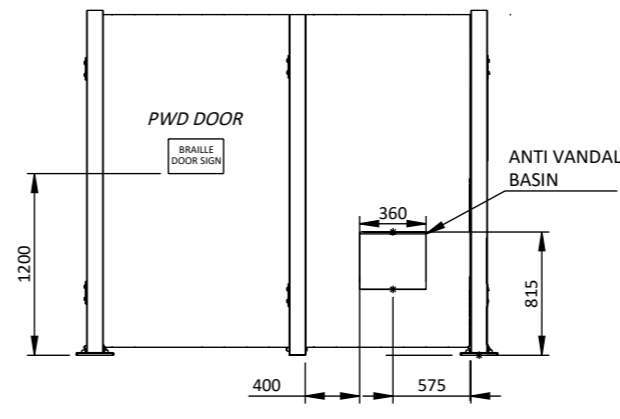

○ PWD EXTERNAL FRONT WALL

GENERAL MATERIALS:

- Posts, framing and roofing components in extruded aluminium.
- Roof sheeting in corrugated profile coated steel.

FINISHES

- Posts, framing and brackets in Class AA25 Anodising finishes, Polyester Powder Coating or wood look aluminium.
Note: Colour may vary between alloys.
- Spigots in Polyester Powder Coating finishes.
Note: 60 Micron minimum on visible faces.

HARDWARE

- Stainless steel anti-vandal fixings.
- Roof screws colour matched roof sheets.